

Parts Breakdown

Model SB-CN-0016 44249

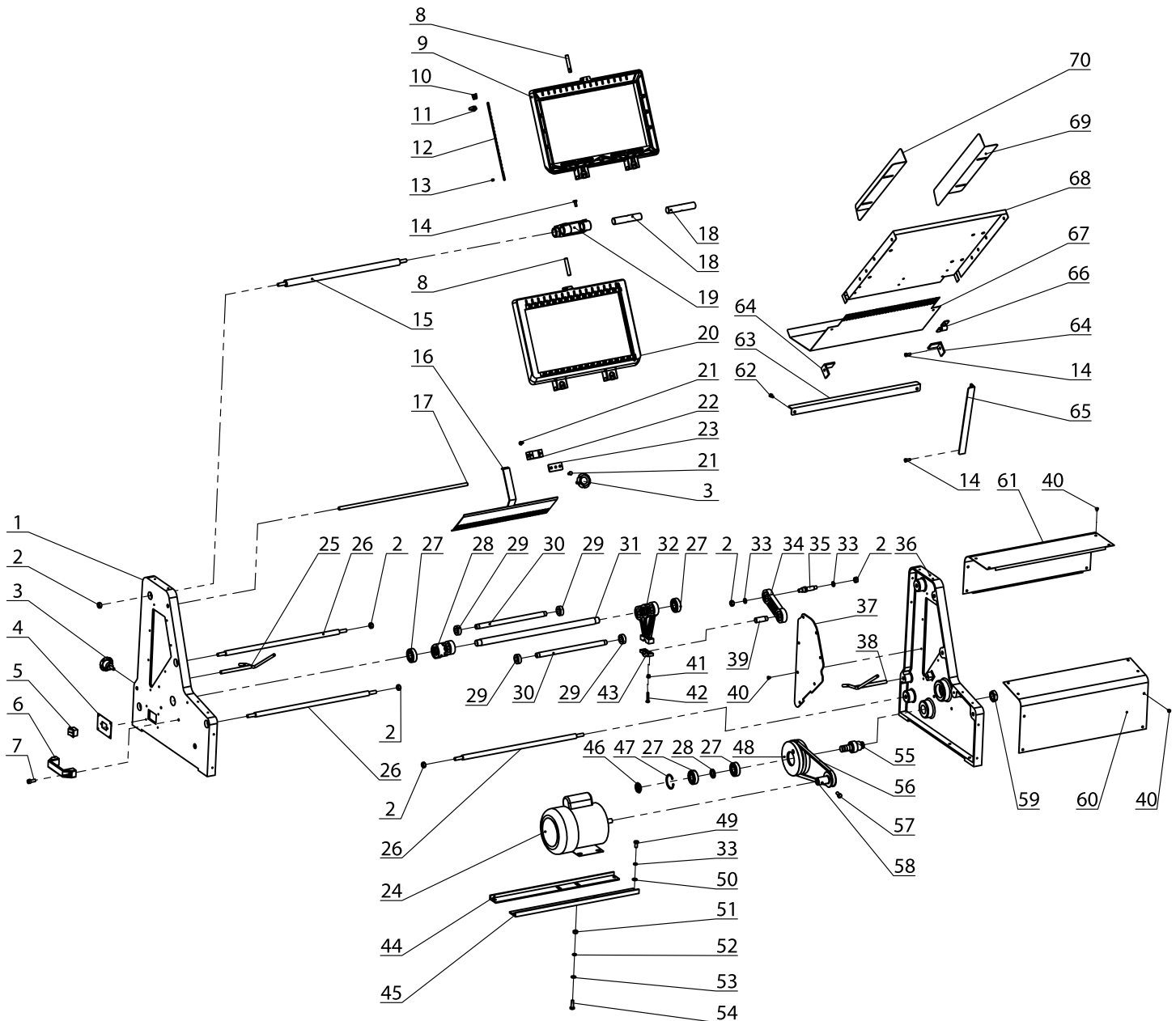

Parts Breakdown

Model SB-CN-0016 44249

Item No.	Description	Position	Item No.	Description	Position	Item No.	Description	Position
63586	Right Wall for 44249	1	63610	Lower Fixed Plate (Right) for 44249	25	63634	Screw M8x16 for 44249	49
63587	Nut M10 for 44249	2	63611	Frame Fixed Rod for 44249	26	63635	Washer Ø8 for 44249	50
63588	Handle for 44249	3	63612	Bearing 6204 for 44249	27	63636	Nut M8 for 44249	51
63589	Control Panel for 44249	4	63613	Plastic Base (Right) for 44249	28	63635	Washer Ø8 for 44249	52
63590	Power Switch for 44249	5	63614	Blade Frame Fixed Ring for 44249	29	63635	Washer Ø8 for 44249	53
63591	Plastic Handle for 44249	6	63615	Blade Frame Fixed Rod for 44249	30	63639	Screw M8x25 for 44249	54
63592	Screw M8x20 for 44249	7	63616	Blade Frame Fixed Rod for 44249	31	63640	Pulley Shaft for 44249	55
63593	Blade Frame Activity Lever for 44249	8	63617	Plastic Base (Left) for 44249	32	63641	Belt for 44249	56
64305	Upper Blade Frame for 44249	9	63618	Washer for 44249	33	63634	Screw M8x16 for 44249	57
63595	Spring for 44249	10	63619	Plastic Bearing Connecting Rod for 44249	34	63643	Motor Pulley Shaft for 44249	58
63596	Blade Frame Retainer for 44249	11	63620	Transmission Fixed Shaft for 44249	35	63644	Nut M22 for 44249	59
14836	Blade for 44249	12	63621	Left Wall for 44249	36	63645	Front Cover for 44249	60
63598	Blade Dowel for 44249	13	63622	Acrylic Board for 44249	37	63646	Upper Cover for 44249	61
63599	Screw M6x16 for 44249	14	63623	Lower Fixed Plate (Left) for 44249	38	63606	Screw M6x12 for 44249	62
63600	Fixed Rod for 44249	15	63624	Sliding Shaft for 44249	39	63648	Fixed Angle Iron for 44249	63
64306	Platen for 44249	16	63625	Screw M5x6 for 44249	40	63649	Fixed Angle Iron for 44249	64
63602	Fixed Rod for 44249	17	63626	Soft Hat M6 for 44249	41	63650	Fixed Angle Iron for 44249	65
63603	Upper Rod for 44249	18	63627	Screw M6x30 for 44249	42	63651	Sloping Plate Retainer for 44249	66
63604	Permanent Seat for 44249	19	63628	Plastic Base Attachment for 44249	43	64308	Tray Bar for 44249	67
64307	Lower Blade Frame for 44249	20	63629	Motor Support (Back) for 44249	44	63653	Sloping Plate for 44249	68
63606	Screw M6x12 for 44249	21	63630	Motor Support (Front) for 44249	45	63654	Width Fixing Plate for 44249	69
63607	Holder for 44249	22	63631	Nut M20 for 44249	46	63655	Width Fixing Plate for 44249	70
63608	Holder Cover for 44249	23	63632	Screw Ø49 for 44249	47	20860	Plastic Lock Bolt of Guides for 44249	
63609	Motor for 44249	24	63633	Pulley for 44249	48	63970	Complete Blade Assembly for 44249	